



25GHz - 40GHz Circularly Phase Array Microstrip Patch Antenna for Millimeter Wave Communication

Md. Farid Shah, Aheibam Dinamani Singh

Abstract: Millimeter wave technology will enable to provide high data rate. It is also expected to provide continuous good quality, low latency video. For high-resolution video, wireless communication will require huge bandwidth. The present 4G spectrum will be unable to meet the demand of each mobile user. To solve bandwidth shortage millimeter wave technology is consider. In this paper present a circularly phase array designed. It is operating in the 25GHz to 40GHz. To enhance bandwidth the array used edge couple parasitic patch arrangement which provides dual resonance. The array is designed in circular phase array with the rotational feeding line. The designed used polyflon CuFlon(tm) low dielectric constant, $\epsilon_r = 2.1$ and tangential loss, $\delta = 0.00045$ with height $h = 1.6\text{mm}$. The designed achieved 8.41dB gain. The array achieved good return loss, S_{11} bandwidth i.e. $-11.83\text{dB} \leq S_{11} \leq -37.8\text{dB}$ (25GHz to 40GHz) and voltage standing wave ratio, $VSWR \leq 1.7$ (25GHz to 40GHz).

Keywords: Millimeter wave (mmWave), Inset feed Microstrip Patch Antenna (IFMPA).

I. INTRODUCTION

The millimeter Wave technology has more bandwidth. It can overcome the shortage of bandwidth. In near future the present 4G LTE will incapable to meet the requirement of huge bandwidth [1]. In 4G peak data rate for high mobility is 100Mbps (up to 360km/h). And 1Gbps for stationary or pedestrian user. During the peak hours speed drops. Its unable offer high data rate to user. So the scientists and researchers looking to explore the mmWave over the decade [2]-[3]. The 5G is the solution to 4G data congestion. In 5G proposed to implement 3GPP Release 15 and ITU IMT-2020 requirements. The proposed goals of 5G are 20Gb/s highest data speed and 100Mb/s operator practiced data rate. In traffic area its goals is 10Mbps/m². And also 106 user/km² link density and 1ms latency are some of goals of 5G. It should have mobility up to 500km/h. The 5G should be retrograde compatibility to LTE/LTE-advanced. And also its onward compatibility to possible future development.

There are many expectation in future generation (5G) communication such as machine to machine, artificial intelligence, industry automation, self-driving. It is not a single technology, it is multiple of technology. The allocation of 5G frequency spectrum many research are going in different frequency under flagship of third generation partnership project (3GPP). Table I shows the spectrum consideration for 5G.

Table I. 5G Frequency Spectrum Consideration

Low band lower 1GHz	Mid band 1GHz - 6 GHz	High bands beyond 24 GHz (mmWave)
600MHz	3.4-3.8GHz	24.25-27.5GH
700MHz	3.8-4.2GHz	z
850/900MH	4.4 -4.9GHz	27.5-29.53GH
z		z
		37-40GHz
		64-71GHz

The frequency from 30GHz to 300GHz and the wavelength from 10mm-1mm is recognized as mmWave band [4]. At 60GHz and beyond the application of mmWave limited for short-range and indoor because of high absorption by rain and surroundings [5], [6]. So to reduce the problem of high absorption of higher mmWave, 26.5GHz to 40GHz will be additional suitable for outdoor applications [1][7]&[8]. South Korea has lunched the 3.5GHz and 28 GHz for 5G spectrum. In USA, Federal Communications Commission (FCC) has chosen 27.5GHz - 28.35GHz for 5G band.

A 2x2 array several ports feeding and multilayer assembly of dual polarized array is presented in [1]. The array achieved 25% impedance bandwidth. To attain the equal polarization port to port isolations remains vital. In coaxial feeding, a coaxial probe through ground and substrate is used to feed the patch. While in coplanar feed the ground and patch remain on same plane. And also some of other feeding methods series, proximity, and aperture coupled, etc. are presented in [9] [21]. In [18], the array of 8x8 has achieved 17 % bandwidth. The array is design used corporate feed. To achieve high gain, electromagnetic coupling is used in the array designed. The designed used RT Duroid 5880 having dielectric constant, $\epsilon_r = 2.2$. The design has substrate height, $h = 0.254\text{mm}$. The tangential loss of RT Duroid 5880 is 0.001 i.e. $\delta = 0.001$.

Revised Manuscript Received on February 05, 2020.

* Correspondence Author

Md. Farid Shah, Department of Electronics and Communication NERIST, Nirjuli-791109, Arunachal Pradesh, India. E-mail: mdfaridshah786@gmail.com

A. Dinamani Singh, Department of Electronics and Communication, NERIST, Nirjuli-791109, Arunachal Pradesh, India. E-mail: aheibam.dinamani@gmail.com

© The Authors. Published by Blue Eyes Intelligence Engineering and Sciences Publication (BEIESP). This is an open access article under the CC BY-NC-ND license (<http://creativecommons.org/licenses/by-nc-nd/4.0/>)

Using polyflon CuFlon(tm) low dielectric constant, $d_r = 2.1$ and tangential loss, $\delta = 0.00045$ with height, $h = 1.6\text{mm}$ an array of 2×2 is presented in this paper. This design has only one layer and also using only one port for feeding. The designed also used rotation feeding line.

A large impedance bandwidth is obtained using the edge-coupled parasitic patch.

II. ANTENNA DESIGN

Inset Feed MPA is easy to design 50Ω input impedance. Consequently, maximum power is pass to the antenna due to impedance matching. Inset Feed MPA is easy to fabrication. It has less price, less outline and light weight [9] [10].

The proposed model of single patch is explained in Section A. And the array designed is discussed in Section B.

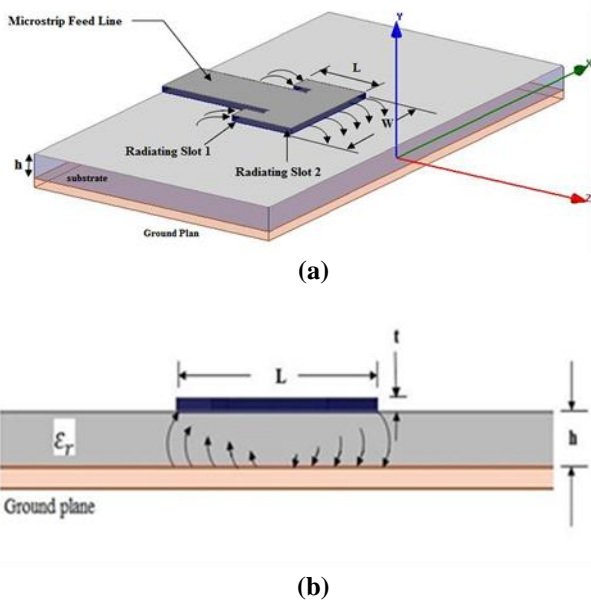

Fig.1: Model of Inset Feed MPA (a) Top and (b) Side view

A. DESIGN OF SINGLE PATCH

Figure 1 discusses the design model of IFMPA. Its input impedance depends on the inset distance Y_o . And it also depend on inset gap I_g . A single element is designed at 31GHz as center frequency using polyflon CuFlon(tm) low dielectric constant, $d_r = 2.1$ and tangential loss, $\delta = 0.00045$ with height, $h = 1.6\text{mm}$. The different parameters are calculated [11] as,

(i) Patch Width (A)

Width of Patch:

$$A = \frac{c}{2f_0 \sqrt{\frac{(d_r + 1)}{2}}} \tag{1}$$

Where

- c = Speed of light.
- f_0 = Centre frequency.
- d_r = Dielectric constant of substrate.

(ii) Patch Length (B)

Effective dielectric constant (d_{reff}) is calculated as below:

$$d_{reff} = \frac{(d_r + 1)}{2} + \frac{(d_r - 1)}{2} \left[1 + 12 \frac{h}{A} \right]^{-\frac{1}{2}} \tag{2}$$

The length of patch is increase due to fringing filed along its length. It is calculated as,

$$\Delta B = 0.412h \frac{(d_{reff} + 0.3) \left(\frac{A}{h} + 0.264 \right)}{(d_{reff} - 0.258) \left(\frac{A}{h} + 0.8 \right)} \tag{3}$$

The physical length (B) is given as:

$$B = \frac{\lambda_s}{2} - 2\Delta B \tag{4}$$

To achieved 50Ω input impedance on the edge of IFMPA is calculated using equation (5) below [12].

$$Y_o = 10^{-4} \{ 0.001699 d_r^7 + 0.13761 d_r^6 - 6.1783 d_r^5 + 93.187 d_r^4 - 682.69 d_r^3 + 2561.9 d_r^2 - 4043 d_r + 6697 \} \frac{B}{2} \tag{5}$$

The figure 2 has shown the measurement of Y_o from edge to the center of patch. To achieve 50Ω input impedance, Y_o is calculated using equation 5 i.e. $Y_o = 0.3552\text{mm}$. Y_f is the port position along width of the patch given by,

$$Y_f = \frac{A}{2} \tag{6}$$

(iii). Ground Dimension

The ground plane measurements are given by equation below,

$$A_g = A + 6h \tag{7}$$

$$B_g = B + 6h \tag{8}$$

Where, A_g and B_g denotes width and length of the ground plane respectively.

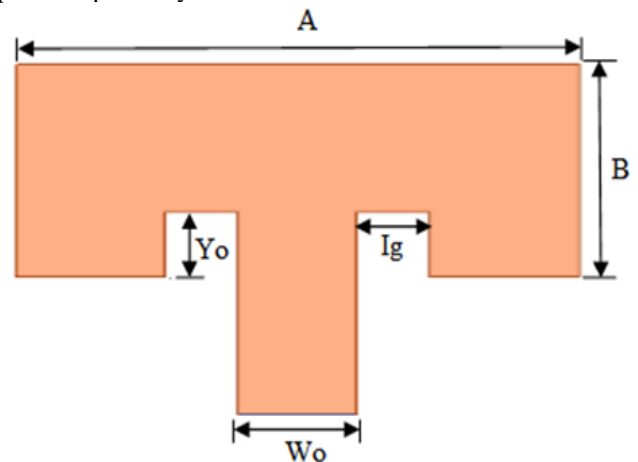

Fig.2: Measurement of radiating patch.



(iv) Design Single Antenna Using HFSS and Results

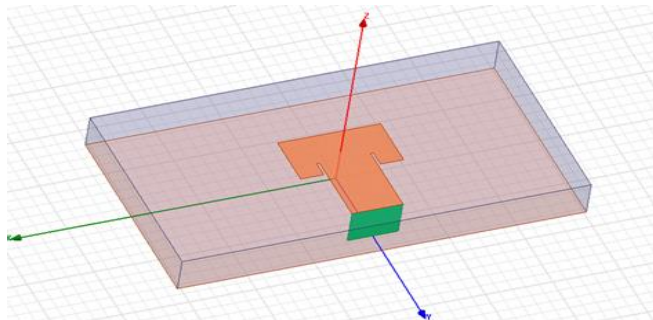

Fig.3: Design of Single Element IFMPA using HFSS 18 Version.

The various parameter of a single IFMPA are calculated using the formulas [13] to [17]. The calculated value of various measurements is given in table I. And also the optimum result values of different parameter through parametric analysis of designed array using HFSS 18 version is given in table I.

Table I. Antenna Parameter

PARAMETER	Length	
	Using Equation (mm)	Parametric Study(mm)
Length of Patch, B	2.125	2.1
Width of Patch, A	3.884	3.83
Substrate thickness, h	1.6	1.6
Ground Length, Bg	11.725	8.4
Ground Width, Ag	13.484	15.2
Inset Gap, Ig	1.9	0.1
Inset Distance, Yo	0.355	0.641
Feeding width Wo		1.9

The designed single element obtains -13.85dB return loss, S_{11} at 31GHz. In the frequency band 27.8GHz to 38.5GHz, S_{11} is below -10dB and is shown in the graph Fig.4 below.

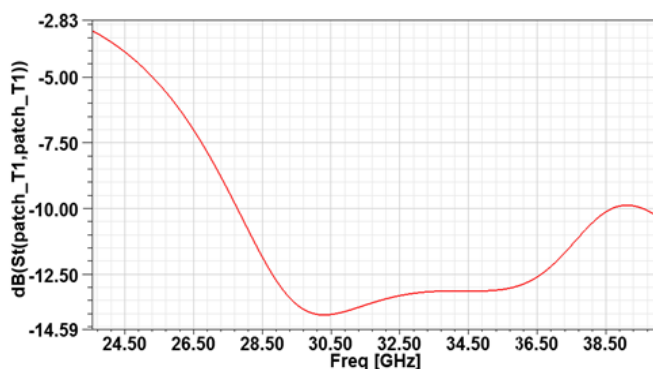

Fig.4: Return loss for 27.8 GHz to 38.5 GHz frequency band.

The antenna has obtain a gain of 6.25dB is shown in fig.5. At 31GHz the designed VSWR value is 1.51. The VSWR values of designed antenna is less than 2.7 in the frequency band 26.5GHz to 39GHz i.e. $VSWR \leq 2.8$ (26.5GHz to 39GHz). The VSWR graph is shown in fig. 6 bellow. The VSWR result confirms that the input port impedance is a well match.

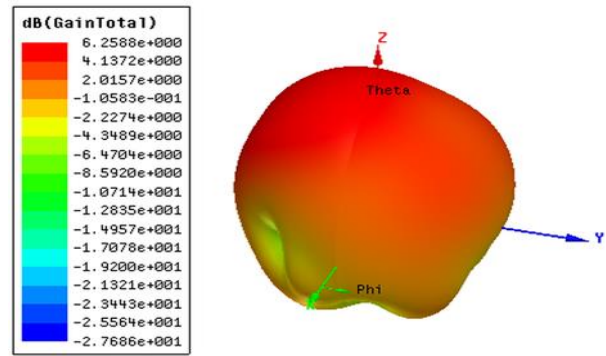

Fig.5: Radiation pattern.

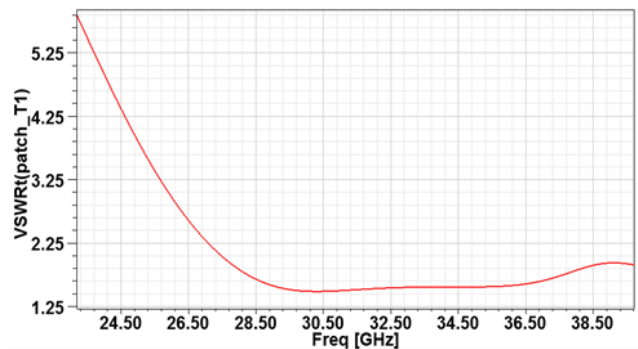

Fig.6: VSWR.

B. DESIGN OF CIRCULAR PHASE ARRAY

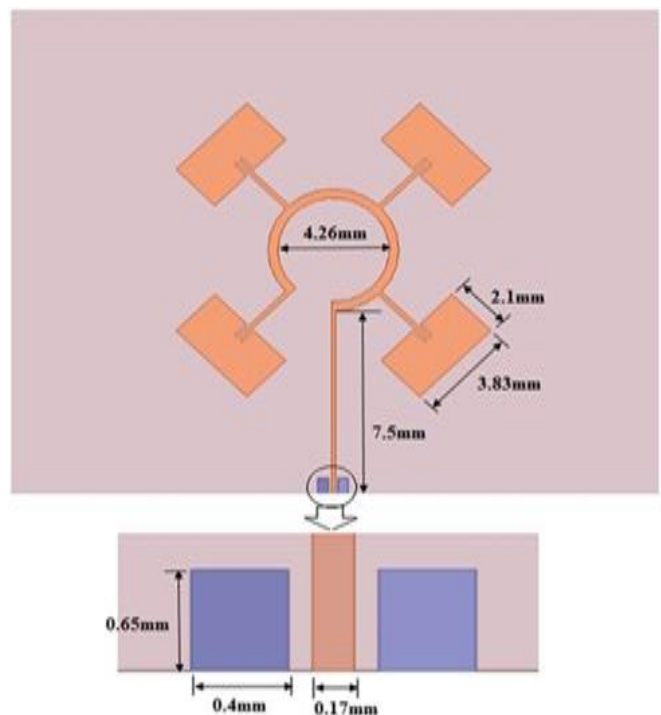

Fig.7: 2x2 Circular phase array model.

Using polyflon CuFlon(tm) low dielectric constant an array is designed. The proposed model has a measurement of 25mm×20mm×1.6mm. In 2x2 arrangements, four IFMPA is arranged in a circular phase using a rational input line and feed line with two parasitic patches.



The two parasitic patches enhanced the bandwidth of the designed. The array reduced unwanted radiation due to circular sequence excitation to the patches [18] to [21]. The array is designed using the HFSS18 version software is shown in Figure 7.

The proposed designed has S_{11} value, $-11.83\text{dB} \leq S_{11} \leq -37.8\text{dB}$. The designed array achieved more than 48% return loss bandwidth (25GHz-40GHz). At 32.46GHz the array has best S_{11} value i.e. -37.8dB . Figure 8 bellow gives the return loss S_{11} graph of 2x2 array.

The figure 9 gives the VSWR graph of 2x2 designed array. The VSWR value of the designed is less than 1.7 in entire band i.e. $VSWR \leq 1.7$ in 25GHz to 40GHz. The proposed array achieved 48% (25GHz to 40GHz) impedance bandwidth ($VSWR < 1.7$).

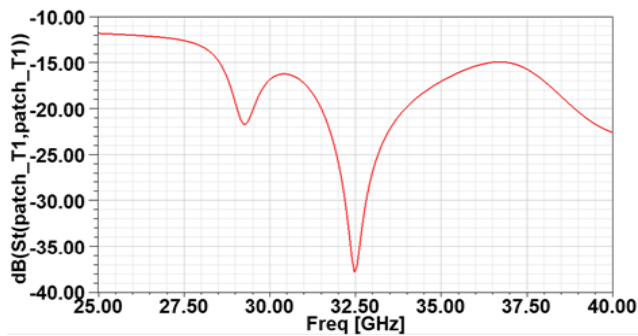

Fig.8: Return loss S_{11} for band (25 GHz-40GHz).

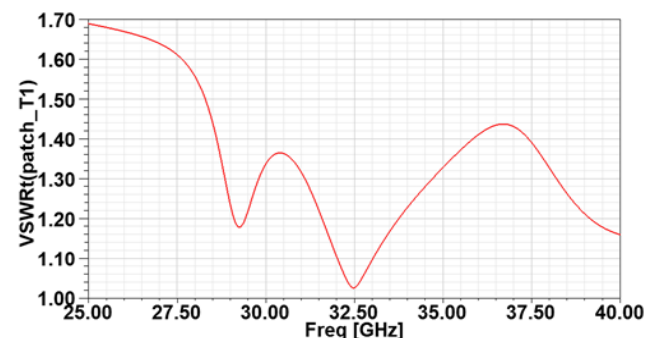

Fig.9: VSWR vs Frequency.

The figure 10 gives the 3D radiation pattern. The design model obtain a maximum gain of 8.49dB.

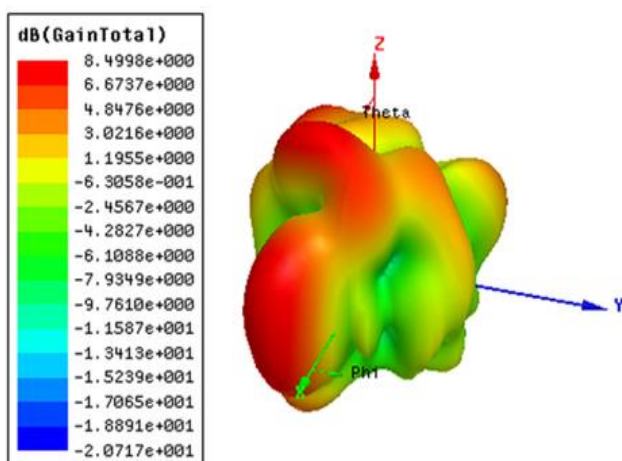

Fig.10: 3D Radiation pattern (Gain).

Table II. Simulation Result

NO. of Patch	Gain	S_{11} Bandwidth $S_{11} \leq -10\text{dB}$	VSWR Bandwidth $VSWR < 2.8$
Single patch	6.25dB	$-10\text{dB} \leq S_{11} \leq -13.85\text{dB}$ (27.8GHz– 38.5GHz)	$VSWR \leq 2.8$ 26.5GHz–39 GHz
Four Patch Array	8.49dB	$-11.83\text{dB} \leq S_{11} \leq -37.8\text{dB}$ (25GHz-40GHz)	$VSWR \leq 1.7$ 25GHz-40GHz

III. RESULT AND DISCUSSION

The proposed array achieved has return loss bandwidth of more than 48%. The model has achieved -37.8dB , S_{11} value at 32.46GHz. And it also achieved $VSWR \leq 1.7$ (25GHz to 40GHz). The designed array has return loss values $-11.83\text{dB} \leq S_{11} \leq -37.8\text{dB}$. It has achieved circularly polarized gain of 8.49dB. The proposed array achieved large bandwidth of S_{11} . And the bandwidth of VSWR and gain is also good for the proposed array. The proposed array will be suitable for the future wireless communication.

IV. CONCLUSION

A 2x2 circular phase array of IFMPA in the lower millimeter wave frequency range (25GHz to 40GHz) has been presented. The proposed array achieved has return loss bandwidth of more than 48%. In the design metamaterial and superstrate should be used to further improve the gain of the array. The proposed model will suitable for short range mmWave communication.

REFERENCE

- Liu S T, Hsu Y W and Lin Y C 2015 A dual polarized cavity-backed aperture antenna for 5G mmW MIMO applications 2015 *IEEE Int. Conf. Microwaves, Commun. Antennas Electron. Syst. COMCAS 2015* 0-4.
- Roh W, Seol J, Park J, Lee B, Lee J, Kim Y and Cho J 2014 [117] Millimeter-Wave Beamforming as an Enabling Technology for 5G Cellular Communications Theoretical Feasibility and Prototype Results 106–13.
- Konanur A S, Gosalia K, Krishnamurthy S H, Hughes B and Lazzi G 2005 Increasing wireless channel capacity through MIMO systems employing co-located antennas *IEEE Trans. Microw. Theory Tech.* 53 1837–43.
- Zhang Y P and Liu D 2009 Antenna-on-chip and antenna-in-package solutions to highly integrated millimeter-wave devices for wireless communications *IEEE Trans. Antennas Propag.* 57 2830–41.
- J. H. Van Vleck, "The absorption of microwaves by oxygen," *Phys. Rev.*, VOL. 71.7, pp. 413–424, 1947.
- Razavi B 2008 Gadgets Gab at GHz *Spectrum* 43 477–85.
- Rappaport T S, Ben-Dor E, Murdock J N and Qiao Y 2012 38 GHz and 60 GHz angle-dependent propagation for cellular & peer-to-peer wireless communications *IEEE Int. Conf. Commun.* 4568–73.
- Azar Y, Wong G N, Wang K, Mayzus R, Schulz J K, Zhao H, Gutierrez F, Hwang D and Rappaport T S 2013 28 GHz propagation measurements for outdoor cellular communications using steerable beam antennas in New York city *IEEE Int. Conf. Commun.* 5143–7.
- David M Pozar 1992 Microstrip antennas *Electromagnetics* 12 381–401.



10. Carver K R and Mink J W 1981 Microstrip Antenna Technology *IEEE Trans. Antennas Propag.***29** 2–24.
11. Constantine A.Balanis 1997 Antenna theory analysis *Wiley Sons Inc*722–3.
12. Ramesh M and Yip K 2003 Design formula for inset fed microstrip patch antenna *J. Microwaves Optoelectron.***3** 5–10.
13. Valdes-Garcia A, Reynolds S, Natarajan A, Kam D, Liu D, Lai J W, Huang Y L, Chen P Y, Tsai M Da, Zhan J H, Nicolson S and Floyd B 2011 Single-element and phased-array transceiver chipsets for 60-GHz Gb/s communications *IEEE Commun. Mag.***49** 120–31.
14. Sharma S K and Nagarkoti D S 2017 Meet the Challenge of Designing Electrically Small Antennas *Microwaves&RF* 6–9.
15. Hu Y, Jackson D R, Williams J T, Long S A and Komanduri V R 2008 Characterization of the input impedance of the inset-fed rectangular microstrip antenna *IEEE Trans. Antennas Propag.***56** 3314–8.
16. Wu S C, Alexopoulos N G and Fordham O 1992 Feeding Structure Contribution to Radiation by Patch Antennas with Rectangular Boundaries *IEEE Trans. Antennas Propag.***40** 1245–9.
17. Prakash P, Abegaonkar M P, Basu A and Koul S K 2013 A simple harmonic reduction technique in inset-fed microstrip patch antennas *2013 7th Eur. Conf. Antennas Propagation, EuCAP 2013* 3474–7.
18. Mathur P and Kumar G 2017 Improved performance of microstrip antenna arrays through electromagnetic coupling at Ka-band *2016 Loughbrgh. Antennas Propag. Conf. LAPC 2016* 29–32.
19. IEEE transactions on Antennas and propagation 1982 Input Impedance and Mutual Coupling of Rectangular Microstrip Antennas *October*1191–6.
20. Lee B and Yoon Y 2017 Low-Profile, Low-Cost, Broadband Millimeter-Wave Antenna Array for High-Data-Rate WPAN Systems *IEEE Antennas Wirel. Propag. Lett.***16** 1957–60.
21. R.Garg,P Bharati,I.Bahl, and A Ittipiboon Microstrip, Antenna Design Handbook, Boston, MA: Artech House,2000.

AUTHORS PROFILE



Md. Farid Shah, received B.E. degree in electronics and communication engineering from Manipur University, Imphal, Manipur, India, in 2011, and M.Tech. in communication system from the University of B.S. Abdur Rahman, Chennai, Tamil Nadu, India in 2014. He is currently pursuing Ph.D. with the North Eastern Regional Institute of Science and Technology,

NERIST, Nirjuli, Arunachal Pradesh, India. His research interests include phase array antennas, switched multibeam antenna arrays, adaptive arrays, dielectric resonator antennas, metamaterial antennas, horn antenna, directional antennas and microwave components development for wireless communications systems.



Aheibam Dinamani Singh, received B.Tech. degree in electronics and communication engineering from the University of North Eastern Hills University, NEHU Shillong, India, in 2004. He completed M.Tech. and Ph.D. in electronics and communication engineering from the North Eastern Regional Institute of

Science and Technology, (NERIST), Nirjuli, Arunachal Pradesh, India, in 2010 and 2015 respectively. He is currently working as an Associate Professor in the Department of Electronics and Communication Engineering, at North Eastern Regional Institute of Science and Technology, (NERIST), Nirjuli, Arunachal Pradesh, India. His research interests are in the area of wireless communication, Fading Channels, Image Processing, Signal Processing, Antennas array, Millimeter-wave antennas. He published over 45 scientific papers in research journals, international and national conferences.