

A Fuzzy Based Techniques For Energy Efficient Cluster Head Selection For Wireless Sensor Network



Abhishek Rai, Kanika Sharma

Abstract: A WSN is split into various clustering nodes in order to obtain proper arrangement and network stability and thus drags the system's lifetime. Each detector node transmits the necessary data to cluster head of each cluster in each cluster-based WSN. Cluster head is liable for collecting the data gathered and forwarding it to sink of network deployed. This manuscript suggests an enhanced Fuzzy-based CH selection algorithm that observes the leftover energy, node compactness and sink distance as input to the Fuzzy inference system. For each node, the eligibility index is calculated to select the head of the cluster. By taking in account the probability assigned to , this algorithm chooses the best candidate for place of the cluster advisor. To each sensor node and helps to increase the energy efficient of network.

Keywords: cluster head, Fuzzy, Energy Efficiency, WSN.

I. INTRODUCTION

WSN is a wireless sensor network that consist of base station and number of nodes. These network used to observe the physical condition or environmental condition like temperature, pressure, humidity and sound collectively transmit data along by network to main position. In recent year wireless sensor area become a leading area of research. A sensor is a device that can detect and respond to physical and environmental condition like heat, light etc. The output of sensor is a electrical signal that passes through controller for further processing. WSN network is built of hundred or thousand of nodes which are connected to each other sensors. Each sensors have different parts like radio trans-receiver, internal and external antenna. Power consumption constraint, Homogeneity, Heterogeneity and some mobility of nodes and scalability these are some characteristics of wireless sensor network. Wireless sensor network use different topologies like Star topology, Mesh topology and Tree topology. Different type of Wireless sensor network are

there like terrestrial, underground, under-water and mobile wireless sensor network. we can also see WSN architecture as shown below.

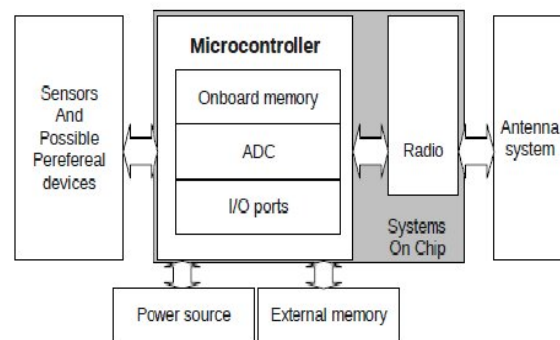

Fig:1 WSN Architecture

Wireless sensor network have a different applications like health observing, environmental monitoring, air pollution observing, forest fire observing, landslide observing, water affection monitoring and Natural disaster prevention and many more. In wsn major concern is about energy consumption, To reduce the energy consumption we use fuzzy based approach in wireless sensor network for opting the cluster head. In fuzzy based approach we should calculate the Eligibility index of each node and after calculation of that we can find the threshold value. we use different fuzzy rules for the selection of cluster head. we use different input parameters for calculation of these rules. One of the major advantage of fuzzy based approach is that our rules are not fixed, we can form as many rules by changing the input parameter. This paper is systematized as follows. In section 2, we showing Energy aware routing schemes. In section 3, we describing our proposed energy efficient routing algorithm. In section 4 we present our simulation result and discussion, In section 5 we finally discuss our conclusion and future directions.

II. RELATED WORK

Energy effectively clustering schemes widely used in our literature. The main motive of clustering is efficient in energy and topology management. A fuzzy based enhanced energy effectively clustering protocol in wireless sensor network that combine both group in approach and fuzzy method.

Revised Manuscript Received on October 30, 2019.

* Correspondence Author

Abhishek Rai*, Electronics and Communication Engineering, National Institute of Technical Teachers' Training and Research, Chandigarh, India. Email: rai199424@gmail.com

Dr. Kanika Sharma, Electronics and Communication Engineering, NITTTR, Chandigarh, India. Email: kanikasharma80@yahoo.com

© The Authors. Published by Blue Eyes Intelligence Engineering and Sciences Publication (BEIESP). This is an open access article under the CC BY-NC-ND license (<http://creativecommons.org/licenses/by-nc-nd/4.0/>)

A Fuzzy Based Techniques For Energy Efficient Cluster Head Selection For Wireless Sensor Network

Nayak and Devulapalliin[17] proposed a fuzzy based technique in which a super cluster head is selected on the basis of some input parameters like distance, residual energy and node density. Logambigai in [19] proposed a Energy efficient grid based routing algorithm for wireless sensor network in which one grid co-ordinator form which reduce the number of hops from one to another node. P.Eak-Une [6] proposed fuzzy based cluster scheme which is distributed in nature and group head selection is done on the basis of remaining energy and intra-cluster distance also taken into consideration. The CHEet al.in [5] describes cluster head opted using fuzzy logic the optimal estimation is done for the number of CHs. This optimality depends upon the value of random number and it is observed that it decides for the reliability of the scheme. Intelligent Fuzzy-based (F3N) group head election[8] was proposed that address the issue that are responsible for reliability of the system, remaining energy etc. CDS-Fuzzy Opportunistic Routing Protocol [9] was proposed The attributes that were targeted include Control burden, total burden, delay and energy wastage. Gupta et al. in [11] proposed in the area of WSNs. The fuzzy was used to overcome the drawbacks of probability approach adopted by the LEACH protocol for CH selection. Three fuzzy headlines are used namely, energy, concentration and centrality that helps in the CH selection. Almomani and Saadeh in[13]proposed a Fuzzy Energy having knowledge tree-based Routing (FEAR) protocol that aim to elongate the network lifetime by taking sensor limited energy into account. The cross layer mechanism is used to save the power. Gajjar et al. in [16]proposed Cluster head selection protocol using Fuzzy Logic (CHUFL). It employs node's parameters namely, remaining energy, node density, quality of routing link with its neighborhood and distance from sink as fuzzy input variables for CH selection. Mehra et al. in [20] suggest a fuzzy based balanced cost CH selection algorithm (FBECS) that consider remaining energy, distance and node density for the input variable to the Fuzzy Inference System. It is the Eligibility index that decides for the selection of node as CH. The proposed scheme FBECS is compared with BCSA and LEACH for the better optimal network performance. The CH selection parameters can be further improved by incorporating the additional factor. Multi hop communication is energy inefficient technique that benefits the proposed scheme.

III. PRELIMINARY MODEL AND SYSTEM

All the sensor node in network form group in which one node acts as a group head, the other node collect information and transmit it to cluster head and cluster head transmit it to base station. Large amount of energy is wasted during this transmit ion of information.

3.1 Assumption

The network frame work of suggested work is sensing the environment by implementing the sensor node in the target area.

The assumption is made as follows:

1. The structure consists of homogenous node with same energy level.

2. The nodes in structure are randomly deployed.
3. The base station and sensor nodes are static once they are deployed.
4. The power supply of sensor nodes are irreplaceable once they are deployed.
5. Base station have limited energy.
6. Failure of sensor node occurs due to power.
7. The structure generates result continuously.

3.2 Radio Model

The energy model which activated in our suggested work is shown in different equation as shown, the efs, EMP and Eelec are different free space, amplifier and electronic energy.

$$E_{tx}(m, d) = \begin{cases} mE_{elec} + mE_{fs}d^2 & d < d_0 \\ mE_{elec} + mE_{mp}d^4 & d > d_0 \end{cases} \quad (1)$$

Where $d = \sqrt{\frac{E_{fs}}{E_{mp}}}$ and d is the separation distance

The energy desire for collection of m bit message is shown below as

$$E_{rx} = mE_{elec} \quad (2)$$

The mean distance calculated from cluster head to it member is given by equation as shown

$$D = \frac{1}{n} \sum_{i=1}^n d_i$$

IV. PROPOSED FUZZY BASED ENERGY EFFICIENT CLUSTERING SCHEME

Sensor node in WSN is to preserve energy. Every cluster has a coordinator known as group head. The sensor node gathered information and transmit it to sink. The cluster head gathered information from its cluster member and pass it to base station. A huge amount of energy is wasted of deployed sensor node during this communication; hence main focus is on energy optimization of the sensor node.

A) Fuzzy base model

The basic terminology of Fuzzy is defined by these terms “not clear, distinct, or precise; blurred”. It can be said as a form of representing the knowledge that is hard to define precisely, however it is entirely dependent upon the context in which it is employed.

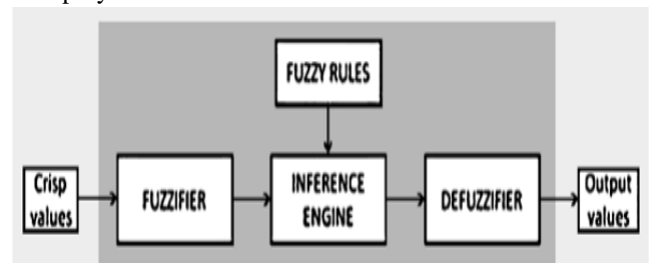

Fig. 2 Building blocks fuzzy system

Fuzzifier In fuzzy based applications, our sources of info are fresh set which require to change into fluffy sets. Each fluffy set is allocated a membership.

Thus, conversion of of fresh set into reasonable phonetic is finished with FuzzifierFuzzy Rule Base: It is having on the off chance that, at that point standards chosen by the client. Guideline base with on the off chance that characterizes the scholastic conduct of the fluffy framework. The fluffy standard base is alluded to as information base.

Inference Engine: Fuzzy motor with data sources and IF THEN principles attempts to recreate the derivation arrangement of individual. Fluffy deduction framework plays a pivotal standard in reaching the determination from the restrictive guideline base.

Defuzzification: Defuzzification procedure do the mapping of the fluffy set obtained from the deduction motor into a fresh yield esteem which can be utilized for making some inference.

B) Fuzzification

The selection of CH is done based on this Fuzzification. The four parameters are considered whereas FBEC only considered three parameters. These parameters are fed to the Fuzzy Interference System (FIS) and membership function value is retrieved.

Fuzzy Rule Base

The membership value that is acquired through the membership function, the final value is fed to the IF-THEN conditions while exploiting the fuzzy AND and OR operators. The 81 rules are evaluated and checked for the repeated pattern. The unique values are considered which 9 in numbers in this work are. Method accord all the output and maximum value is chosen from combine fuzzy set. To obtain the eligibility index by fuzzy logic, we used Mamdani system which used mostly because of its characters tics

Table1: Fuzzy input function

Input	Linguistic variables		
Residual energy	Low	Medium	High
Distance to BS	close	Medium	Far
Node density	sparse	Medium	Dense
Network average energy	Low	Medium	High

3.1.3 Defuzzification

For Defuzzification centre of area method is used as given by equation

$$z^* = \frac{\int \mu B(z).zdz}{\int \mu B(z)dz} \quad (3)$$

It is noted that, the Gaussian function is used to show the intermediate values whereas trapezoidal function is used for the boundary values. The value of each function should be between 0 and 1. The received input is transformed into crisp set that helps in determining the eligibility index for each node through the following equation. The equation for Gaussian membership function is shown as

$$f(x) = e^{-\frac{(x-\mu)^2}{2\sigma^2}} \quad (4)$$

Once the eligibility index of all nodes is calculated threshold is calculated as shown

$$TH = \frac{Node(i).p * mean(ei)}{1 - Node(i).p * mode\left(r, \frac{1}{Node(i).p}\right)}$$

The fuzzy tool is used and the following parameters are used for the selection of CH in the network. The residual energy, distance to the BS, node proximity and average energy are

taken for the selection of CH. The residual energy is classified into three categories, low, medium and high. ‘Medium’ is given as Gaussian waveform as shown in Fig. However, the other two are designed in the trapezoidal form.

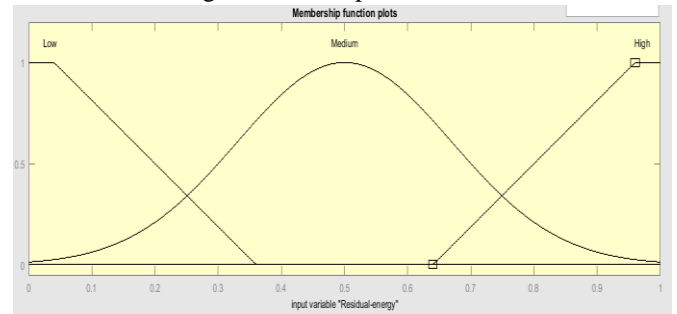

Fig.3 Input-Var:Residual Energy

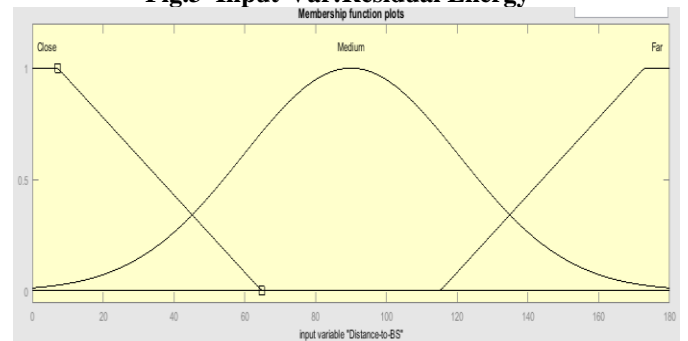

Fig.4 Input-Var:DTBS

Table: 2 Defuzzifier output Function

Output	Linguistic Variable
Eligibility index	Very best, Best, Better, Far better, Good, Fair, Bad, Worse, Worst

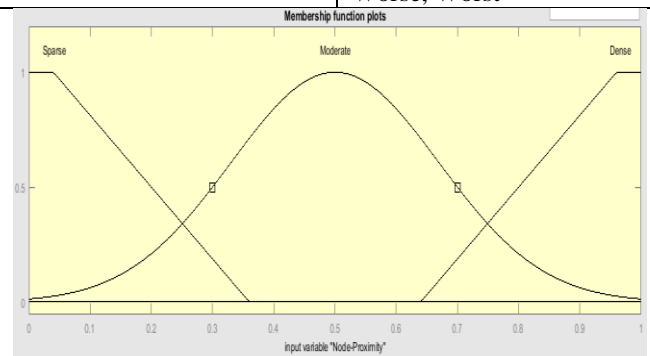

Fig.5 Input-Var Node density

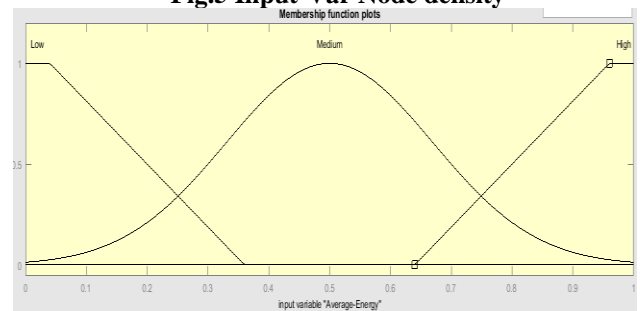

Fig.6 Input-Var Average Energy

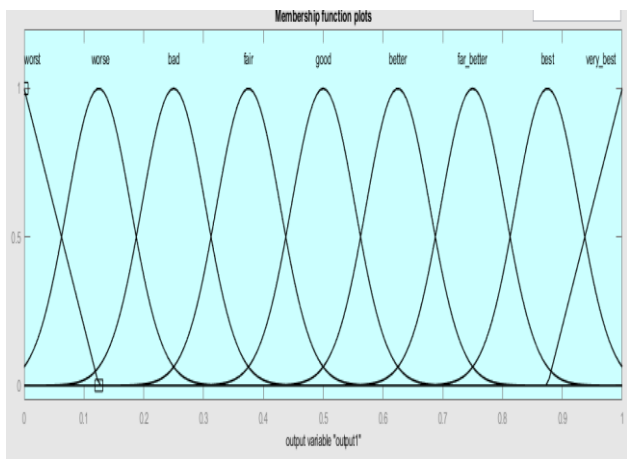

Fig.7 Output-Var: Eligibility Index

Table: 3 Simulation Parameters

Parameter	Value
Network coverage	(100,100) m
BS location	(50, 175) m
Node Number	100
Initial energy (Quantity)	In Joules 0.5
E_{elec}	50nJ/bit
E_{efs}	10pJ/bit/m ²
E_{mp}	0.0013pJ/bit/m ⁴
d_0	87m
E_{da}	5nJ/bit/signal
Data packet size	4000bits

V. PERFORMANCE EVALUATION AND DISCUSSION

Proposed work is better in performance in comparison to FBECS and CAFL. The simulation work is performed in MATLAB where all type of membership function are available and implementation is easier. SN are distributed in the area. The position of base station is kept at far place from target area so as to generalize the protocol.

A) Alive nodes per round

If large number of nodes is alive in the network maximum information is collected and information is transmitted to base station. For CAFL first node dies at 657, for FBEC first node dies at 852 and for proposed work first node dies at 1202 and for CAFL last node dies at 1149, for FBECS dies at 1449 and for proposed work dies at 5500.

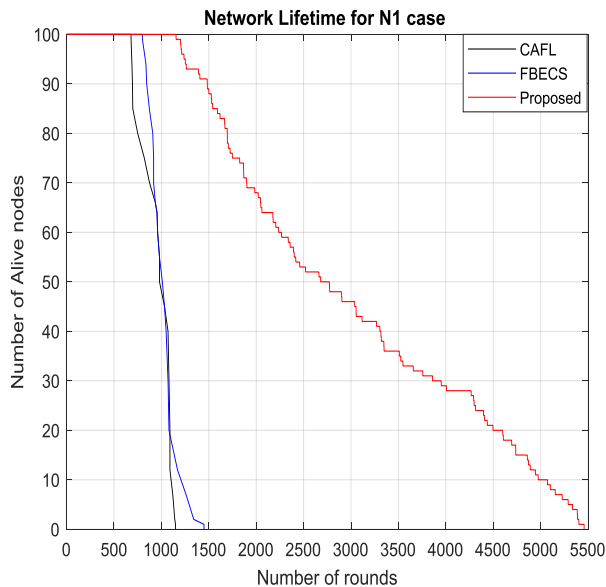

Fig. 9 Number of alive Nodes

B) FND, QND and HND

The stability period of the proposed protocol is 1154 rounds which are more than the FBECS and CAFL which cover only 800 and 680 rounds, respectively. The reason behind such improvement is the introducing the fuzzy approach and the average energy of the nodes.

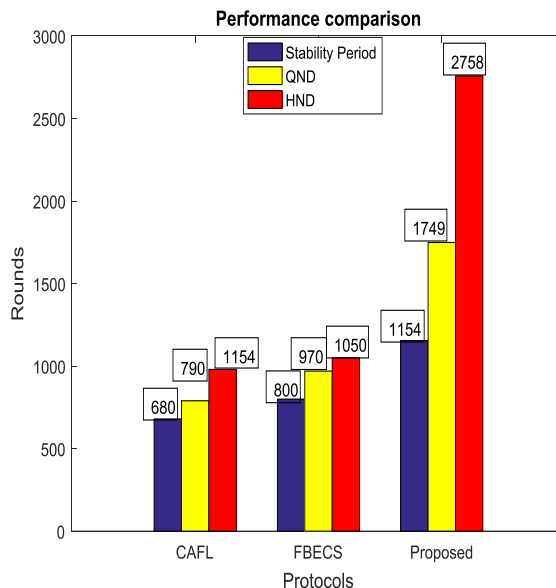

Fig: 8 Performance Comparisons

C) Average Energy in Joules

The remaining energy of the proposed protocol is more as compared to the other protocols FBECS and CAFL. In Fig. 4.10, the residual energy of the proposed protocol is shown that is getting reduced with the passage of rounds. However, in case of Fig. 4.10, the comparison of average energy of the nodes for the proposed protocol is shown against the other protocols namely, CAFL and FBECS.

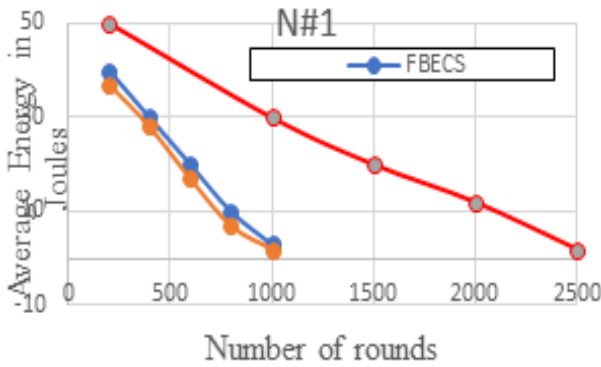

Fig. 10 Network Average Energy

D) Packets send to Base station

As shown in the result packets send to base station is more in our proposed algorithm in compare to FBECS and CAFL. We can explain it as throughput as more is packet transmitted more is the collected information.

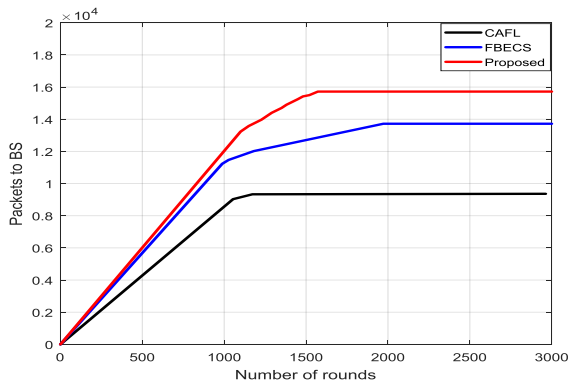

Fig. 11 Packets send to Base station

VI. CONCLUSION

Separation distance of sensor node from base station play a vital role for cluster head selection as power should be increase exponentially as distance increases and if sensor node which place far from the base station play role of cluster head than node dies quickly. In our proposed work probability of cluster head selection should be done on some fuzzy rules, our proposed algorithm having a better result in comparison to other algorithm FBECS and CAFL. The amount of information is processed to base station is far better than its comparative to number of rounds.

REFERENCES

- Aggarwal, Charu C., and Chandan K. Reddy. "Data clustering." Algorithms and Application, Boca Raton: CRC Press (2014).
- Erilli, N. Alp, et al. "Determining the most proper number of cluster in fuzzy clustering by using artificial neural networks." Expert Systems with Applications 38.3 (2011): 2248-2252.
- Naik, Anima, Suresh Chandra Satapathy, and K. Parvathi. "Improvement of initial cluster center of c-means using teaching learning based optimization." Procedia Technology 6 (2012): 428-435.
- Babushka, R 2009, „Fuzzy Clustering in Fuzzy and neural control disc“ Course lecture notes, Delft, the Netherlands, Delft University of Technology.
- Bramier, M & Wiuf, C 2007, „Co-clustering and visualization of gene expression data and gene ontology terms for Saccharomyces cerevisiae using self-organizing maps“, Journal of Biomedical Informatics, vol. 40, no. 2, pp. 160–173.

- Mehdizadeh, E, Sadi-Nezhad, S & Tavakkoli-Moghaddam, R 2008, „Optimization Of Fuzzy Clustering Criteria By A Hybrid PSO And Fuzzy C-Means Clustering Algorithm“, Iranian Journal of Fuzzy Systems, vol. 5, no. 3, pp. 1-14.
- Zou, K, Wang, Z, Pei, S, & Hu M 2009, „A new initialization method for fuzzy c-means algorithm based on density“, Fuzzy Information and Engineering, vol. 54, pp. 547-553.
- Jose V. V. Sobral., Aldir S. Sousa., Harilton S. Araujo., Rodrigo A. R. S. Baluzy., Raimir Holanda Filho., Marcus V. S. Lemosz., and Ricardo A. L. Rabelo., “A Fuzzy Inference System for Increasing of Survivability and Efficiency in Wireless Sensor Networks,” Journal on Networks, 2013.
- Bhandari, Dinabandhu, Nikhil R. Pal, and D. Dutta Majumder. "Fuzzy divergence, probability measure of fuzzy events and image thresholding." Pattern Recognition Letters 13.12 (1992): 857-867.
- Lee C. C., Fuzzy Logic in Control Systems: Fuzzy Logic Controller - Part I and part II, IEEE Trans. on Systems, Man and Cybernetis, 20(2), 404-418 and 20(2), 491-435, 1994.
- Metin Akay, Editor, Nonlinear Biomedical Signal processing Volume - I (Fuzzy Logic, Neural Networks and New Algorithms), IEEE press products, 2000.
- Anno, Junpei, et al. "A cluster head decision system for sensor networks using fuzzy logic and number of neighbor nodes." 2008 First IEEE International Conference on Ubi-Media Computing. IEEE, 2008.
- P. M. L. Chan, R. E. Sheriff, Y. Hu, P. Conforto, and C. Tocci, "Mobility management incorporating fuzzy logic for a heterogeneous ip environment," IEEE Communications Magazine, vol. 39, no. 12, pp. 42-51, 2001.
- Indranil Gupta, Denis Riordan, Srinivas Sampalli, "Cluster-head election using fuzzy logic for wireless sensor networks", Communication Networks and Services Research Conference 2005. Proceedings of the 3rd Annual, pp. 255-260, 2005.
- Arabi, Zohre. "HERF: A hybrid energy efficient routing using a fuzzy method in wireless sensor networks." In 2010 International Conference on Intelligent and Advanced Systems, pp. 1-6. IEEE, 2010.
- Mehra, Pawan Singh, M. N. Doja, and Bashir Alam. "Zonal based approach for clustering in heterogeneous WSN." International Journal of Information Technology (2017): 1-9.
- Nayak, Padmalaya, and Anurag Devulapalli. "A fuzzy logic-based clustering algorithm for WSN to extend the network lifetime." IEEE sensors journal 16.1 (2015): 137-144.
- Singh, Samayveer, Satish Chand, and Bijendra Kumar. "Energy efficient clustering protocol using fuzzy logic for heterogeneous WSNs." Wireless Personal Communications 86.2 (2016): 451-475.
- Tamandani, Yahya Kord, Mohammad Ubaidullah Bokhari, and Qahtan Makki Shallal. "Two-step fuzzy logic system to achieve energy efficiency and prolonging the lifetime of WSNs." Wireless Networks 23.6 (2017): 1889-1899.
- Zytoune, Ouadoudi, Youssef Fakhri, and Driss Aboutajdine. "A balanced cost cluster-heads selection algorithm for wireless sensor networks." International Journal of Computer Science 4.1 (2009): 21-24.
- Mehra, Pawan Singh, Mohammad Najmud Doja, and Bashir Alam. "Fuzzy based enhanced cluster head selection (FBECS) for WSN." Journal of King Saud University-Science(2018).

AUTHORS PROFILE



Abhishek Rai: Abhishek Rai received Bachelors of Technology degree in Electronics and Communication Engineering from DAV institute of engineering and technology, Jalandhar, Punjab, India in 2015. He is pursuing Masters of engineering degree in Electronics and Communication Engineering from National Institute of Technical Teacher's Training and Research, Punjab University, Chandigarh, India. His current research interests are in WSN.



Dr. Kanika Sharma Assistant Professor, Electronics and Communication Department, NITTTR, sector 26, Chandigarh, PHD, ME and BE (ECE)

