

Behavioural Study of R/C Natural Draught Cooling Tower under Gravity Load using Different Support Orientations



Saikat Chowdhury, Baibaswata Das, Abhishek Hazra

Abstract-In the field of both atomic and thermal power-plant the Natural Draught Cooling Tower plays a very important role. The vulnerability of NDCT lies in its hyperbolic shell structure whereas the supporting columns play a pivotal role in load distribution and heat transfer mechanism. Throughout our study effort has been given to find out the behavior of Reinforced Concrete NDCT under static loading using two different types of support orientation. For enhanced accuracy finite element analysis method has been adopted. The geometry of NDCT has been created by strictly following IS code provisions. A detail analysis has been presented in terms of deflection, stress propagation and strain behavior under gravity load. In the final stage a comparison of response behavior of the hyperbolic shell and supporting columns has been prepared with various key components of stress strain behavior.

Keywords-NDCT, Support Orientation, Finite Element Method, Shell Structure,

In general the hyperbolic shell is constructed either by Steel or R.C.C also sometimes galvanized steel is used. The general considerations for the accurate design of the hyperbolic shell structure are as per the provisions of IS 11504:1985.

These provisions are given for the effective design based on -

- a) Dead Load
- b) Seismic Load
- c) Thermal Load
- d) Wind Load
- e) Any other loads like construction load,

etc.

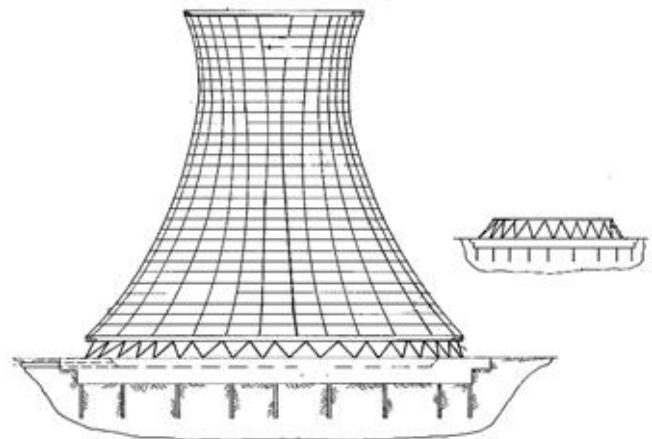

Fig 1 :Hyperboloid shell of NDCT with Supporting column at base

2) Supporting Columns:

Though the hyperbolic shell is the main vulnerable part but the supporting columns play a considerable role in the operation of load transfer. The hyperbolic shell is supported on either diagonal or vertical sets of supporting columns along with external or internal ring beams. The materials selected for the erection of the supporting columns is either very high-strength, or prefabricated concrete. The whole system of the racker column and ring beam provides a very important system which gives adequate resistance to NDCT against instability due to static as well as dynamic load. Another important duty played by these supporting columns is to conduct the heat transfer mechanism for NDCT. The supporting columns are so provided that through the gap between them the air from atmosphere enters into the cooling tower which plays a major role in the basic working mechanism for which the cooling towers are preferred.

B. Objective of study:

I. INTRODUCTION

Natural draught cooling tower in today's world is classified as a landmark for power plant both nuclear as well as thermal because of their contribution to efficient energy output and thus they play a very prominent role in establishing a balance with the environment. Cooling tower more precisely Natural draught cooling tower known as NDCT is basically follows the principal of temperature difference of inside air and the air outside. To go with this principal the NDCT are generally consists of large hyperbolic shell structures which are generally thin in thickness. The higher strength, durability, and large area available at base are the reasons that the hyperbolic shape of NDCT.

A. Basic components a natural draught cooling tower:

Basic components of which a natural draught cooling tower consists are-

- 1) Hyperbolic shell.
- 2) Supporting Columns known as Racker Column.

1) Hyperbolic Shell:

The vulnerable part of Natural Draught Cooling Tower is its hyperbolic shell structure due its huge shape and size.

Revised Manuscript Received on September 25, 2020.

* Correspondence Author

Saikat Chowdhury*, UG Student, Dr. Sudhir Chandra Sur Degree Engineering College, Kolkata- W.B, India Email id-saikatchowdhuryg@gmail.com

Baibaswata Das, Assistant Professor, Dr. Sudhir Chandra Sur Degree Engineering College, Kolkata- W.B, India Email id-baiba.tanan@dsec.ac.in

Abhishek Hazra, Assistant professor, Narula Institute of Technology, Agarpara, Kolkata- W.B, India Email id- abhishek.hazra@nit.ac.in

© The Authors. Published by Blue Eyes Intelligence Engineering and Sciences Publication (BEIESP). This is an open access article under the CC BY-NC-ND license (<http://creativecommons.org/licenses/by-nc-nd/4.0/>)

Behavioural Study of R/C Natural Draught Cooling Tower under Gravity Load using Different Support Orientations

Our work is generally concentrated on the behavioral study of the NDCT under different support orientation under static or gravity load we have chosen 2 different support orientations for our study-

- a) Hyperbolic Shell structure with A-shaped supporting columns at the shell base.
- b) Hyperbolic Shell structure with X-shaped supporting columns at the shell base.

Thus we have chosen our objectives for these study as- Analysis of the hyperbolic shaped shell structure as well as supporting columns under gravity load .

II. PROBLEM FORMULATION

Natural Draught Cooling Tower has two main basic parts-one is the Hyperbolic Shell Structure and another is inclined or vertical columns known as Racker Columns on which the shell is supported. The vulnerable part of the NDCT is its Hyperbolic Shell Structure because of its huge mass. Furthermore the supporting columns are also subjected to huge amount of loading due to the large hyperbolic shaped shell of the NDCT. For these reasons the stress generation in the structure is very high and for that the structure needs to be analyzed with much care. Considering all these aspects we have opted for finite element method for the analysis purpose because FEM discretizes the structure into number of finite elements having same property then formulates the required equation for each element and finally combines them to achieve required solution.

A. Geometrical modeling:

For our study we have taken **Niederaussem Power-plant NDCT** which is the tallest of the natural draught cooling towers in the world as our reference structure as shown in fig 2. The shell of hyperbolic shape as well as the supporting columns on which it is supported can clearly be observed.

As per the objective of this study required boundary conditions for NDCT is taken as below-

- The shell structure with its top edge free and it is supported on A-shaped supporting columns with fixity at the base.
- The shell structure with its top edge free and it is supported on X-shaped supporting columns with fixity at the base.

The hyperbolic geometry has been strictly followed as per specifications of IS: 11504 – 1985 (clause 6.3.1) which states that-

$$\frac{r^2 + y^2}{r_{th}^2 b^2} = 1$$

$$b = \frac{r_{th} H_t}{\sqrt{r_t^2 - r_{th}^2}} = \frac{r_{th} H_b}{\sqrt{r_b^2 - r_{th}^2}} \dots\dots\dots (1)$$

Where,

r = radius of revolutions.

r_{th} = Throat radius

r_b = Base radius

H_t = Top end to throat height

H_b = Throat to base height

The data that have been taken from the reference cooling tower is given below-

Total height of the tower- 200 m

The diameter at the outlet (top radii)-88.41 m

The radius at the inlet (bottom radii) – 136 m

The diameter at throat- 85.26 m

The thickness of hyperboloid shell structure- 250 mm

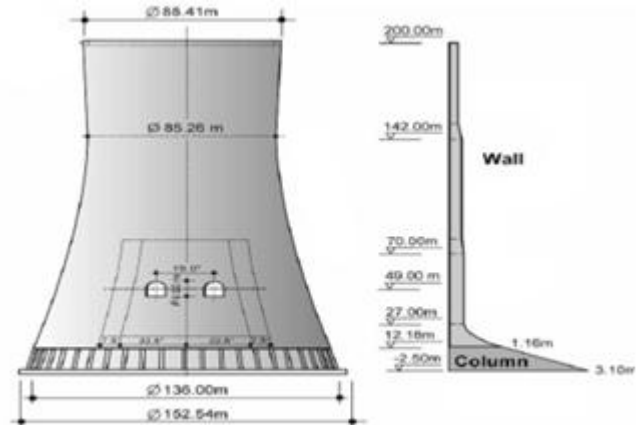

Fig-2: Details of reference NDCT

P.C.- www.researchgate.net

The throat is at a distance of 129.82 m from the base and 58 m from the top end of the shell structure. Supporting Column dimension= 750mm x 750mm

Based on equation (1) the hyperbolic revolution of the shell structure of NDCT has been calculated.

Geometry values to create model

Table I. Geometry Values

Key points	X-Coordinates	Y-Coordinates
1	44.2	58
2	43.71	48
3	43.31	38
4	43	28
5	42.78	18
6	42.66	8
7	42.71	-12.982
8	42.95	-25.964
9	43.35	-38.946
10	43.9	-51.928
11	44.59	-64.91
12	45.43	-77.89
13	46.4	-90.874
14	47.5	-103.856
15	48.71	-116.838
16	50.02	-129.82

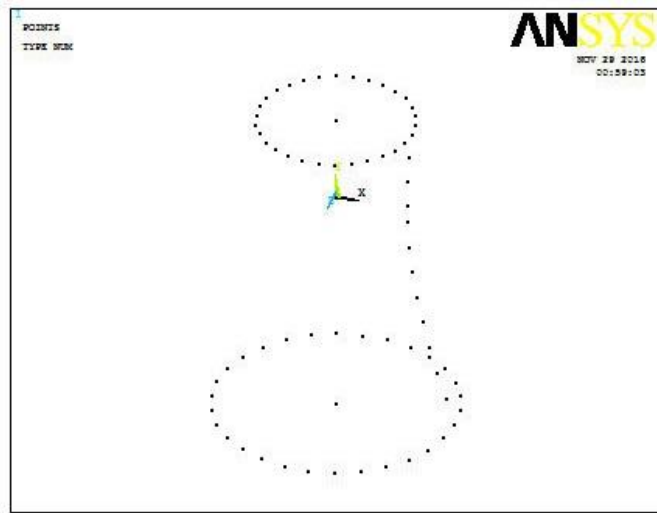

Fig 3: Key points for the hyperboloid revolution of NDCT

B. Element selection:

ANSYS MADPL provides a variety of element types which enables user to model different geometry and structure with flexibility. Every element is distinguished based on their various DOFs, no of nodes, etc. For our study the element which we have selected-

1. **SHELL 181** finite strain shell element is selected for the shell structure and
2. **BEAM 188** finite element beam is selected for the supporting columns.

C. Material properties:

In our study we have assumed that the Natural Draught Cooling Tower hyperbolic shell as well as the supporting columns is made with Reinforced Cement Concrete (R.C.C) having elastic, homogeneous and isotropic property. The parameters that we have considered for our study-

Table II. Material Properties

Parameters	Values
Elastic Modulus	31 Gpa
Poisson's Ratio	0.15
Density	25 KN/m ³

SHELL Element supported on X-shaped Supporting Columns

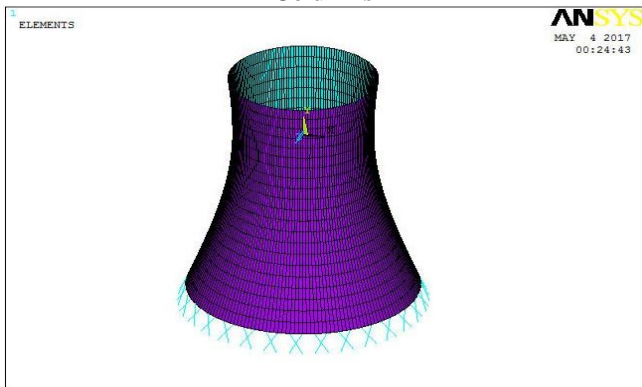

Fig 4: Element division after meshing

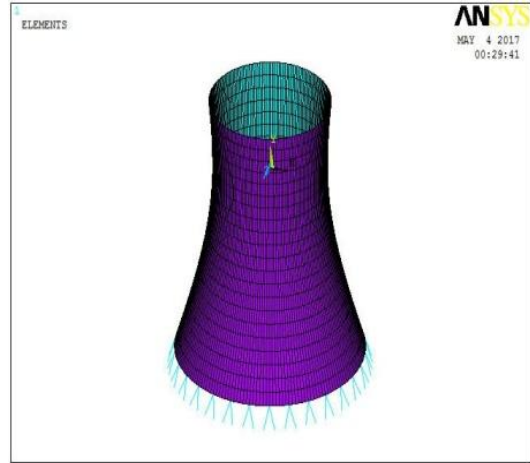

Fig 5: Element division after meshing SHELL Element supported on A-shaped Supporting Columns

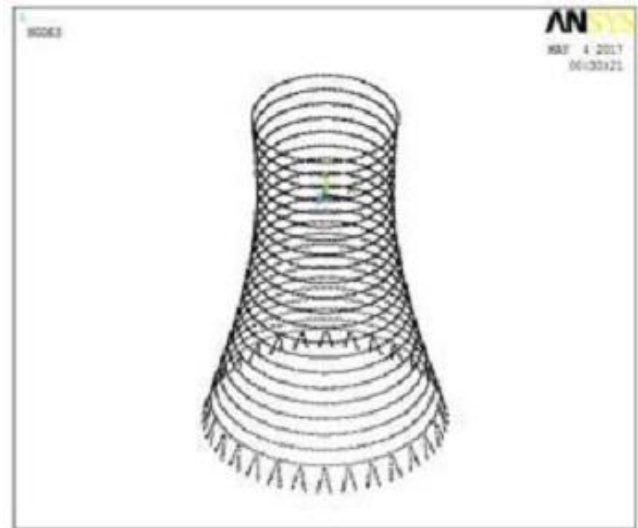

Fig 6: Position of Nodes after Meshing

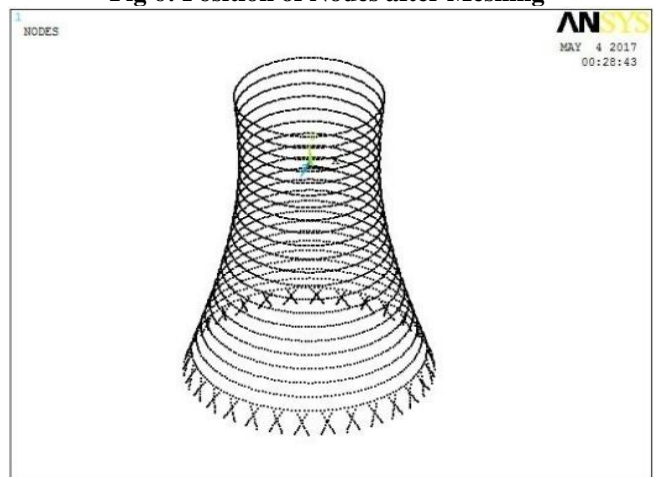

Fig 7: Position of Nodes after Meshing

III. SOLUTION METHODOLOGY

Natural Draught Cooling tower having hyperbolic shape is generally subjected to

- a) Static Loading
- b) Dynamic Loading



Behavioural Study of R/C Natural Draught Cooling Tower under Gravity Load using Different Support Orientations

Our study is more concentrated about the Static Loading because of the huge magnitude of gravity load that's coming from the hyperbolic shell.

A. Static analysis:

Natural Draught Cooling Tower has a huge amount of self weight because of the large hyperbolic shape of the cooling tower. Due to this self weight the Natural Draught cooling tower is subjected to huge gravity load based on the acceleration due to gravity. Another importance of static analysis is that the huge load has to be supported by the racker columns at the bottom of the Hyperbolic Shell Structure. So the behavior of the hyperbolic shell under gravity load is very important for the stress concentration that is generated in the racker columns. In our study the analysis of the NDCT under gravity load due to gravitational acceleration (g) having value 9.81 m/s^2 is done in Ansys 14.0 MADPL. And the propagation in the shell structure and the subsequent racker column as well as the deflection of the structure due to the loading has been presented.

IV. RESULTS AND DISCUSSION

The results have been showed utilizing Ansys 14.0 MADPL in the general post processor section. The results here have been plotted in terms of contour plotting which clearly shows the deflected shape of the NDCT and the propagation of Principal Stress as well as Von-mises Stress in not only the hyperbolic shell but also the supporting racker columns. The strain due to the principal and Von-mises stress have also been plotted. Finally a clear comparative study has been shown between the deflection, stress values and the corresponding strain data for the NDCT with A-Type and X-Type support orientation.

A. Static analysis:

Static analysis for shell structure with a-shaped support at base

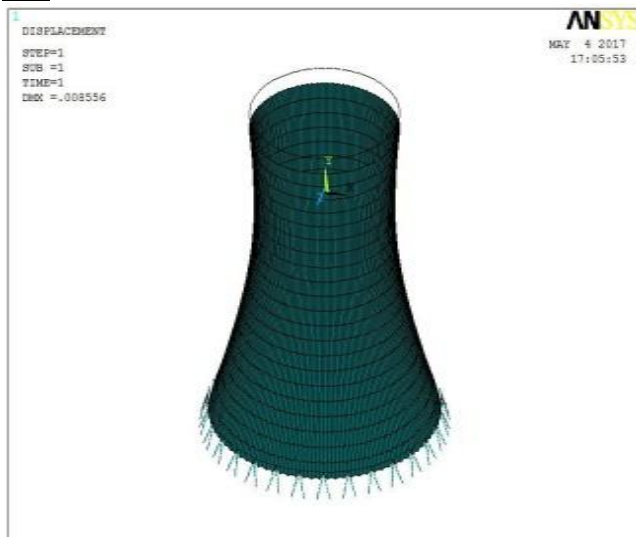

Fig.8 Displaced Structure

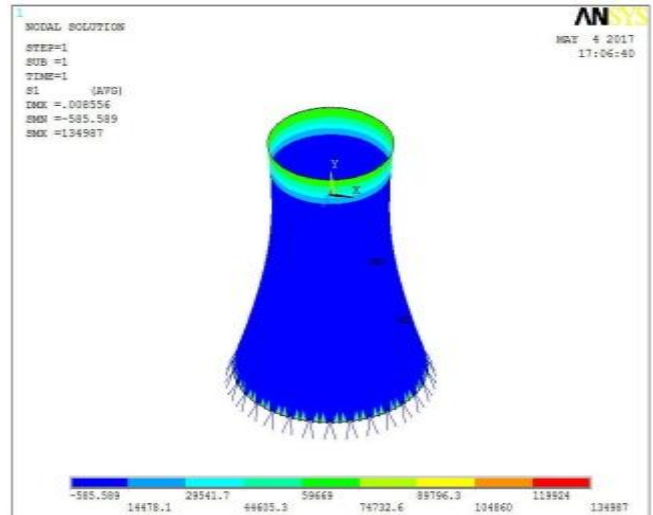

Fig.9 Static Analysis 1st Principal Stress

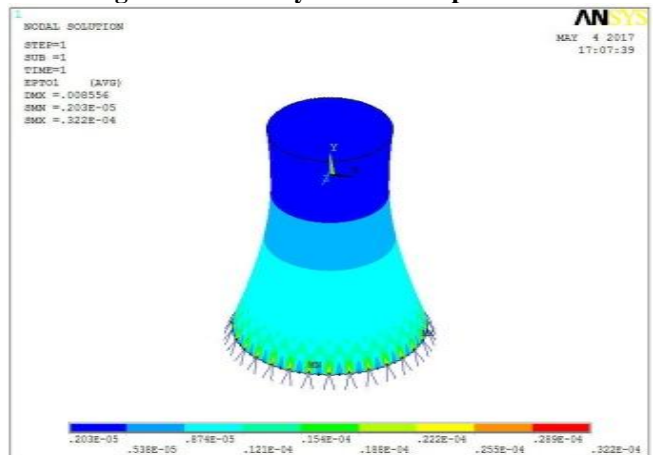

Fig.10 Static Analysis 1st Principal Strain

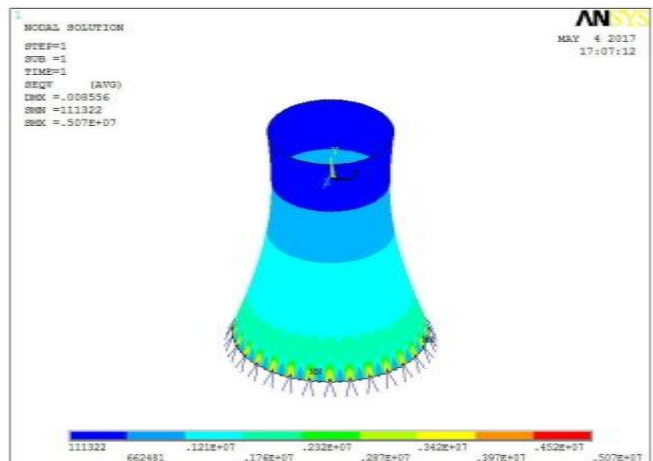

Fig.11 Static Analysis Von-mises stress

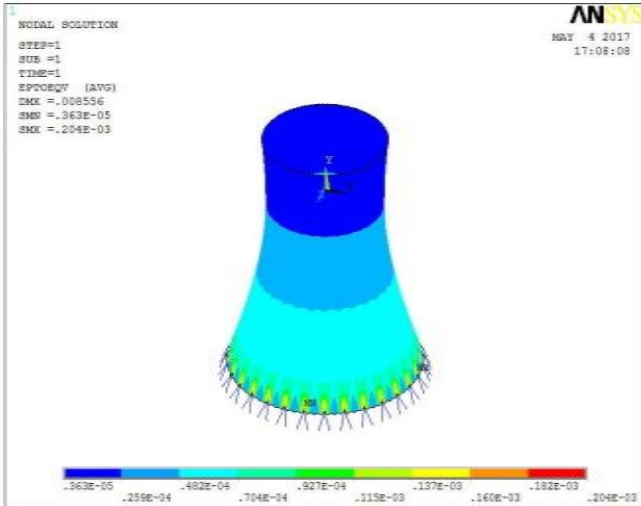

Fig.12 Static Analysis Von-mises strain

Static analysis for shell structure with x-shaped support at base

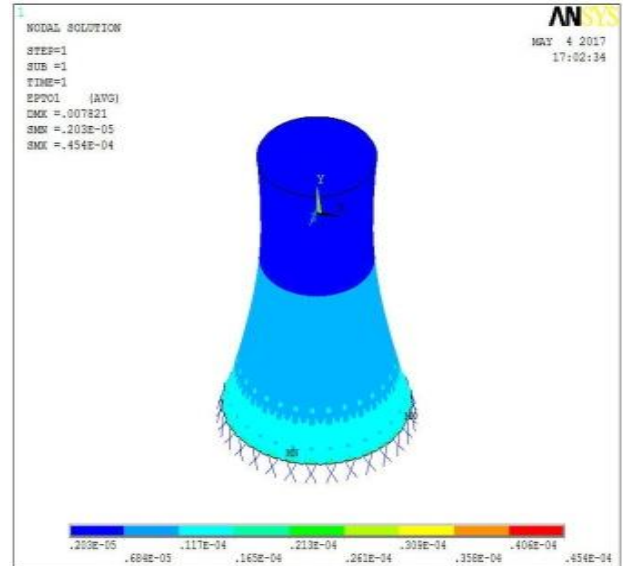

Fig.15 Static Analysis 1st Principal Strain

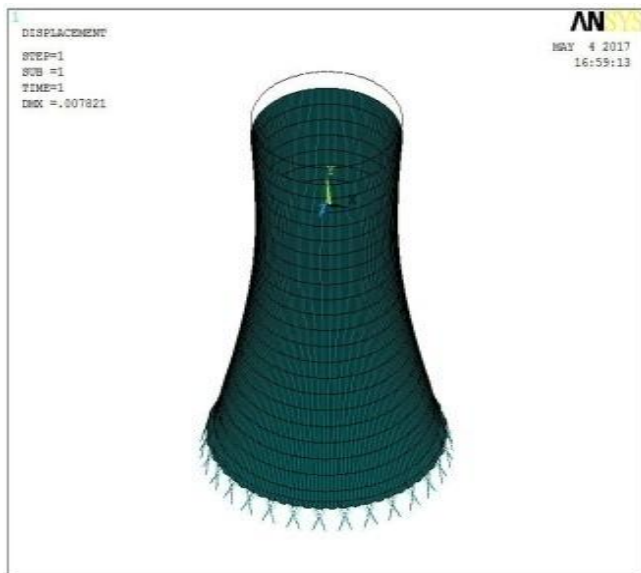

Fig.13 Displaced Structure

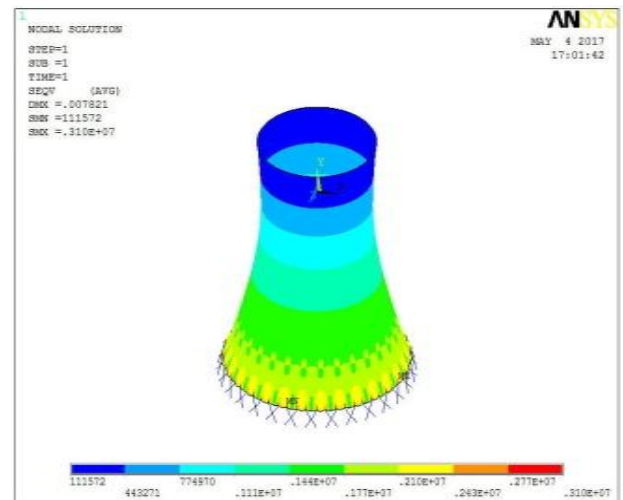

Fig.16 Static Analysis Von-mises stress

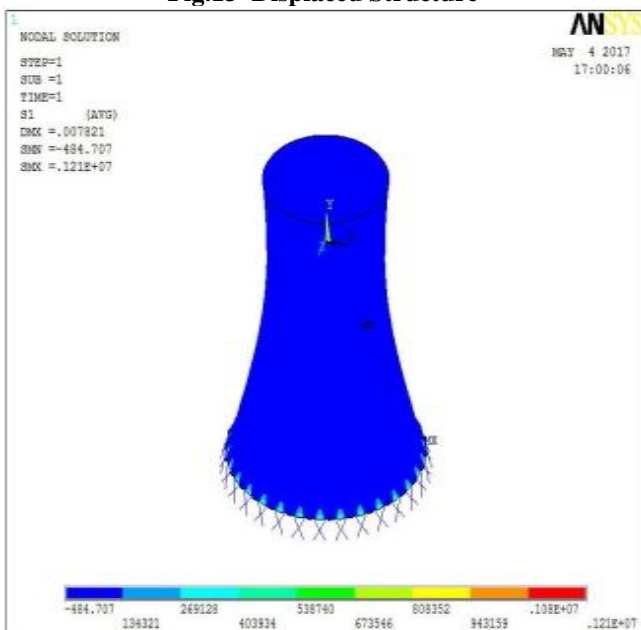

Fig.14 Static Analysis 1st Principal Stress

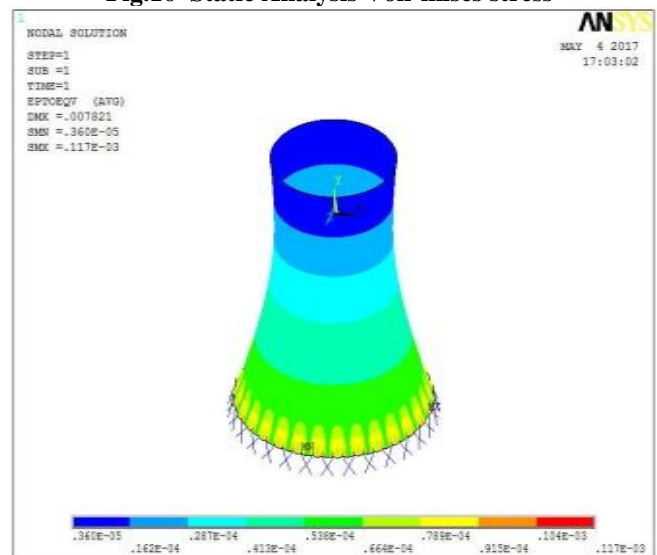

Fig.17 Static Analysis Von-mises strain

Behavioural Study of R/C Natural Draught Cooling Tower under Gravity Load using Different Support Orientations

B. Static analysis result list:

Table III. Result Data of Static Analysis

Analysis Criteria	A- Shaped Support	X- Shaped Support
Maximum Deflection (m)	0.008556	0.007821
Maximum Principal Stress (N/m ²)	134987	0.121x10 ⁷
Maximum Principal Strain	0.322x10 ⁻⁴	0.454x10 ⁻⁴
Maximum Von-mises Stress (N/m ²)	0.507x10 ⁷	0.31x10 ⁷
Maximum Von-mises Strain	0.204x10 ⁻³	0.117x10 ⁻³

C. Comparison of results:

Table IV. Comparison of Results Static Analysis

Deflection Criteria	Deflection in shell structure with A-type supporting columns are higher than X-type supporting columns
Principal Stress Criteria	Principal Stress in shell structure with X-type supporting columns are higher than A-type supporting columns
Von-mises Stress Criteria	Von-mises Stress in shell structure with A-type supporting columns are higher than X-type supporting columns

V. CONCLUSION

Because of the large structure, high stress generation and vulnerability under static and dynamic loading designing a Natural draught cooling tower requires detail analysis. In our study it is clearly shown that the supporting columns under the hyperbolic shell structure governs the stress propagation and deflection of NDCT. Also the results are influenced by the different support orientation as well as the boundary conditions. Our analysis and its subsequent results provide a clear overview of the response and behavior of R/C NDCT under gravity loading. This comparison and the set of results can be properly utilized in the structural design consideration.

REFERENCES:

1. Ansary, A M El, A A El Damatty, and A O Nassef. "Optimum Shape and Design of Cooling Towers." World academy of Science,

- Engineering and Technology 9 (2011): 4–13. Print.
2. Journal, International et al. "Finite Element Analysis for Structural Response of Rcc Cooling Tower Shell Considering Alternative Supporting." September 2016(2012):n.pag. Print.
3. Karisiddappa, M. "Finite Element Analysis of Column Supported Hyperbolic Cooling Towers Using Semi-Loof Shell and Beam Elements." Engineering Structures 20.1–2 (1998): 75–85. Web.
4. Ke, S. T. et al. "A New Methodology for Analysis of Equivalent Static Wind Loads on Super-Large Cooling Towers." Journal of Wind Engineering and Industrial Aerodynamics 111 (2012): 30–39. Web.
5. Grant, S, and T Y Yangs. "REFINED ANALYSIS OF THE SEISMIC RESPONSE OF COLUMN-SUPPORTED COOLING TOWER." II.3 (1980): n. pag. Print.
6. Gould, P.L., S.K. Sen, and H. Suryoutomo. "Dynamic Analysis of Column- supported Hyperboloidal Shells." Earthquake Engineering & Structural Dynamics 2.3 (1973): 269–279. Web.
7. Makovička, D. "Response Analysis of an RC Cooling Tower Under Seismic and Windstorm Effects." 46.6 (2006): 17–21. Print.
8. Reed, D. A., and Robert H. Scanlan. "Time Series Analysis of Cooling Tower Wind Loading." Journal of Structural Engineering 109.2 (1983): 538–554. Web.
9. Yang, By T Y, M Asce, and Rakesh K Kapania. "• Finite Element Random Response Analysis of Cooling Tower." 110.4 (1984): 589–609. Print.
10. "Theoretical Study of Earthquake Response of a Cooling Tower.pdf." : n. pag. Print.

AUTHORS PROFILE



Saikat Chowdhury, UG Student, Dr. Sudhir Chandra Sur Degree Engineering College, Kolkata- 700074, W.B, India
Email id- saikatchowdhury@gmail.com



Baibaswata Das, Assistant Professor, Dr. Sudhir Chandra Sur Degree Engineering College, Kolkata- 700074, W.B, India
Email id- baiba.tanan@dsec.ac.in



Abhishek Hazra, Assistant professor, Narula Institute of Technology, Agarpara, Kolkata- 700109, W.B, India
Email id- abhishek.hazra@nit.ac.in